

KR 8 R1620 arc HW



Technical data

Maximum reach	1621 mm
Rated payload	8 kg
Rated supplementary load, rotating column / link arm / arm	0 kg / 0 kg / 10 kg
Rated total load	18 kg
Pose repeatability (ISO 9283)	± 0.04 mm
Number of axes	6
Mounting position	Floor; Ceiling; Wall
Footprint	333.5 mm x 307 mm
Weight	approx. 184 kg

Axis data

Motion range	
A1	±170 °
A2	-185 ° / 65 °
A3	-120 ° / 180 °
A4	±165 °
A5	-115 ° / 140 °
A6	±350 °

Speed with rated payload

A1	220 °/s
A2	178 °/s
A3	270 °/s
A4	430 °/s
A5	430 °/s
A6	630 °/s

Operating conditions

Ambient temperature during operation	5 °C to 45 °C (278 K to 318 K)
--------------------------------------	--------------------------------

Protection rating

Protection rating	IP54
Protection rating, in-line wrist	IP54

KUKA Roboter GmbH

Zugspitzstrasse 140, 86165 Augsburg, Germany. Tel.: +49 821 797-4000, www.kuka-robotics.com

Details provided about the properties and usability of the products are purely for information purposes and do not constitute a guarantee of these characteristics. The extent of goods delivered and services performed is determined by the subject matter of the specific contract. No liability accepted for errors or omissions.

0000-255-791 / V9.1 / 02.02.2017 / en



Controller

Controller	KR C4 smallsize-2; KR C4 compact
------------	-------------------------------------



Teach pendant

Teach pendant	KUKA smartPAD
---------------	---------------

Work envelope graphic

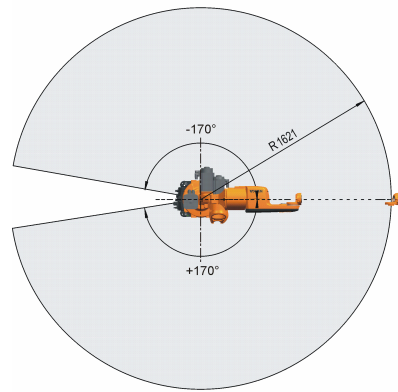
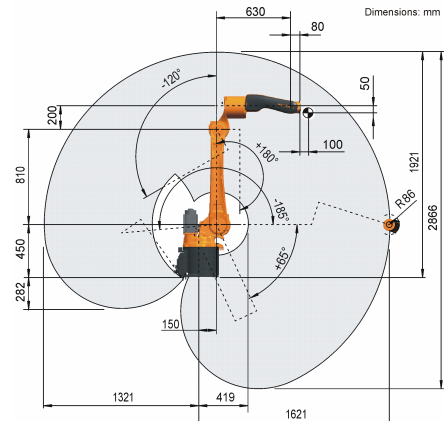

Mounting flange

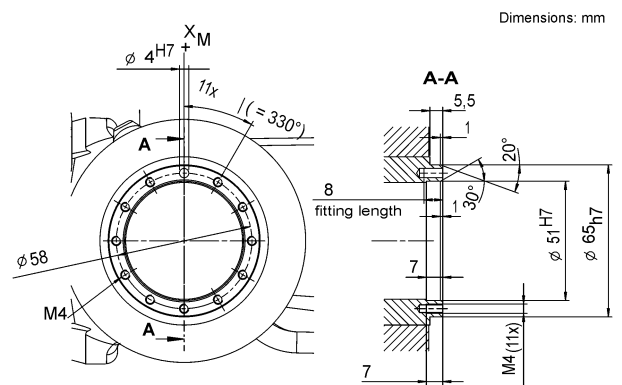

KUKA