

KR 500 R2830



Technical data

Maximum reach	2826 mm
Rated payload	500 kg
Rated supplementary load, rotating column / link arm / arm	0 kg / 0 kg / 50 kg
Rated total load	550 kg
Pose repeatability (ISO 9283)	± 0.08 mm
Number of axes	6
Mounting position	Floor
Footprint	1050 mm x 1050 mm
Weight	approx. 2385 kg

Axis data

Motion range	
A1	±185 °
A2	-130 ° / 20 °
A3	-100 ° / 144 °
A4	±350 °
A5	±120 °
A6	±350 °

Speed with rated payload

A1	90 °/s
A2	80 °/s
A3	75 °/s
A4	90 °/s
A5	83 °/s
A6	130 °/s

Operating conditions

Ambient temperature during operation	10 °C to 55 °C (283 K to 328 K)
--------------------------------------	---------------------------------

Protection rating

Protection rating	IP65
Protection rating, in-line wrist	IP65



Controller

Controller	KR C4
------------	-------



Teach pendant

Teach pendant	KUKA smartPAD
---------------	---------------

Work envelope graphic

Dimensions: mm

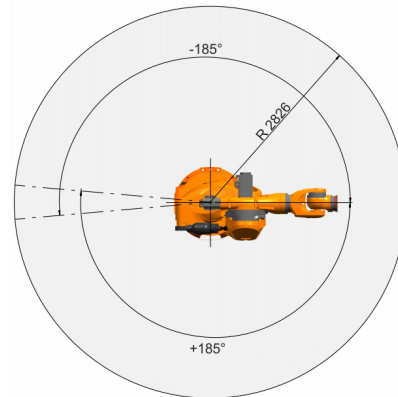
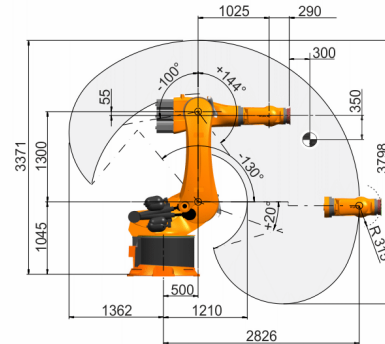

Mounting flange

Dimensions: mm

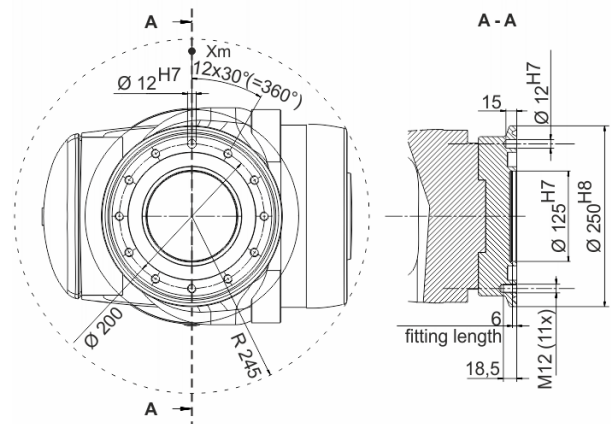

KUKA Roboter GmbH

Zugspitzstrasse 140, 86165 Augsburg, Germany. Tel.: +49 821 797-4000, www.kuka-robotics.com

Details provided about the properties and usability of the products are purely for information purposes and do not constitute a guarantee of these characteristics. The extent of goods delivered and services performed is determined by the subject matter of the specific contract. No liability accepted for errors or omissions.

0000-233-238 / V17.1 / 02.02.2017 / en

KUKA